

Data Sheet



Article number: 0108069

Description: Retaining ring JK 52 DIN 984

Measures

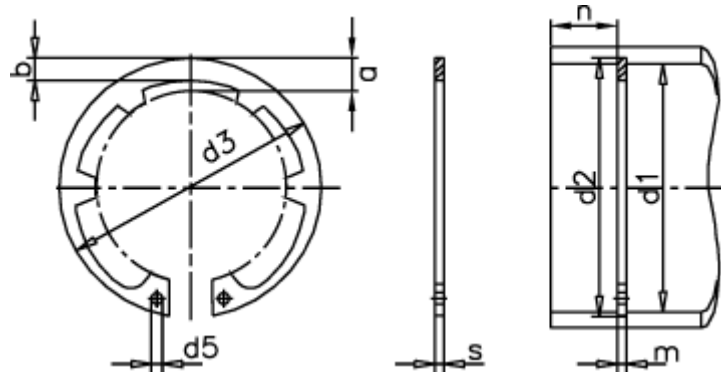

a max	= 8.2	FN kN	= 42.0	s	= 2.00
AN mm ²	= 252.0	FRg kN	= 12.0	t	= 1.50
b	= 4.7	FR kN	= 60.2	tol	= +0,30
d1	= 52	g	= 2.0	tol	= -0.07
d2	= 55.0	K kN-mm	= 108.0	tol	= +1,10-0,46
d3	= 56.2	m min	= 2.15	Tong	= ZGJ-3
d5 min	= 2.5	Nominal drive	= 4.5	Weight kg/1000	= 9.40
Description	= JK 52	Number of serrations	= 6		